

◆ 选型 Type Selection

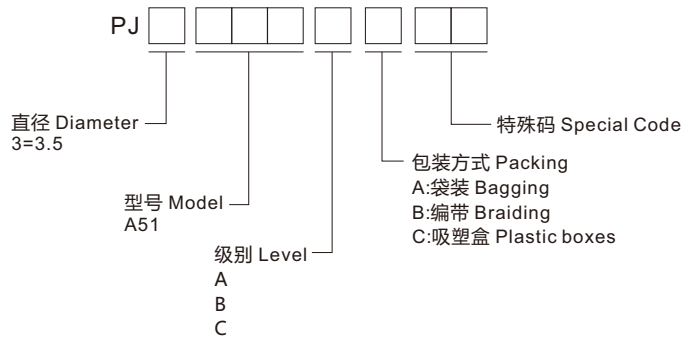

◆ 规格 Specifications

- 接点额定值 Contact Rating : 0.5A 30V DC
- 接触电阻 Contact Resistance : $\leq 100\text{m}\Omega$
- 绝缘电阻 Insulation Resistance : $\geq 100\text{M}\Omega$ 500V DC
- 介电 Dielectric : $\geq 500\text{V AC/1 minute}$
- 插拔力 Insertion and Extraction Force : 3 ~ 20N
- 电气寿命 Electric Life : $\geq 5000\text{cycles}$
- 工作温度 Operating Temp : $-20^\circ\text{C} \sim +70^\circ\text{C}$
- 储存温度 Storage Temp : $-30^\circ\text{C} \sim +70^\circ\text{C}$

◆ 材质 Material

- 端子 Terminal : 铜合金 Copper Alloy
- 外壳 Housing : PPA/PA6T

◆ 图表 Diagram

■ PJ3A51

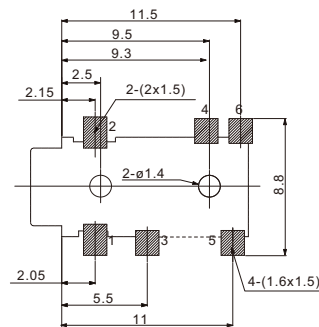
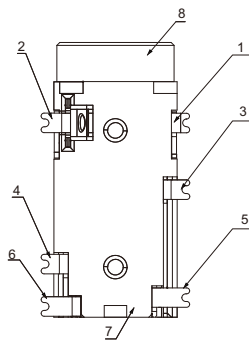
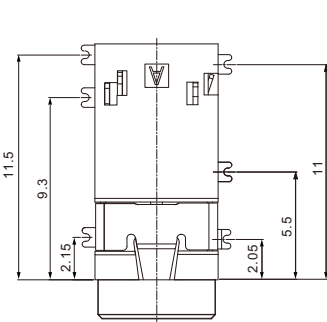

电路图
Circuit diagram

